



IRON BOW™
HEALTHCARE
SOLUTIONS

**EXPANDING THE
BOUNDARIES OF
HEALTHCARE**

Horus Scope Series 1 Cradle for Cisco CLINiC Gen 2 Installation and User Guide

**Iron Bow Part Number:
ACC-CRADLE-CS1-B01**

**For use with:
CLINiC-C-12X27-B02**

Document Part # DOC-UG-CRADLE-S1-C-B

Version 3.0

3/01/2021

Copyright © 2021 Iron Bow Technologies
All Rights Reserved.
Specifications subject to change without notice.

For general inquiries, contact:
Iron Bow Healthcare Solutions
2303 Dulles Station Boulevard, Suite 400
Herndon, VA 20171
Toll: 800.338.8866
Tel: 703.279.3000
www.ironbowhealthcare.com

For support, contact:
Iron Bow Client Service Center
Toll: 833.476.6269 (833.IRONBOW)
Email: CSC@ironbow.com

Contents

Introduction	5
Installing the Horus Scope Cradle	6
Preliminary Steps	9
Installing Cradle in Side-Mounted Position	10
Attaching Horus Scope Cable and Clamp.....	12
Moving Cradle from Side to Rear Mounting Position.....	13
Operating the Horus Scope	16
Horus Scope Functions and Components	16
Basic Horus Scope Operations.....	17
Changing Horus Scope Lens Attachments.....	18
Troubleshooting Tips.....	18
Video Scaler Settings.....	19

Figures

Figure 1. CLINiC with Horus Scope (1) and cradle assembly (2)	5
Figure 2. Horus Scope cradle attachment parts	6
Figure 3. Horus Scope cables and cabling tools	7
Figure 4. Horus Scope – CLINiC connectivity diagram	8
Figure 5. Fully assembled CLINiC 12x (rear view)	9
Figure 6. Horus Scope components (front view)	Error! Bookmark not defined.
Figure 7. Horus scope components (rear, side and bottom views)	Error! Bookmark not defined.

Safety & Maintenance

Please read these instructions completely before operating the equipment and keep this manual for future reference. The Horus Scope cradle assembly is designed for use with Iron Bow CLINiC systems and should not be used with any other system. The information in this manual is intended for persons who install and operate the equipment as well as repair or servicing personnel,

It is recommended that the Iron Bow CLINiC is used with an AC isolation transformer which is incorporated into the optional stand available for this system, or with a mobile cart with an internal isolated AC supply. Prior to installation and start-up of Horus scope, carefully read the user manual. As with all technical devices, the proper function and safety operation of this device depends on the user complying with the safety and cleaning recommendations presented in these operating instructions. In addition, please make sure it does not appear damaged or broken. If there are breaks on the outer casing or other visual defects, please contact the manufacturer or a certified service facility. The Jed Med Horus Scope user manuals can be found at: <https://www.jedmed.com/pages/horus-scope-manuals>

Introduction

This user guide covers basic Horus Scope Series 1 operation instructions, as well as installation steps of a Horus Scope cradle assembly. The cradle assembly allows convenient and safe positioning of the Horus Scope on a Cisco CLINiC Gen 2

The instructions described in this guide apply to the CLINiC models: part numbers CLINiC-C-12X27-B01

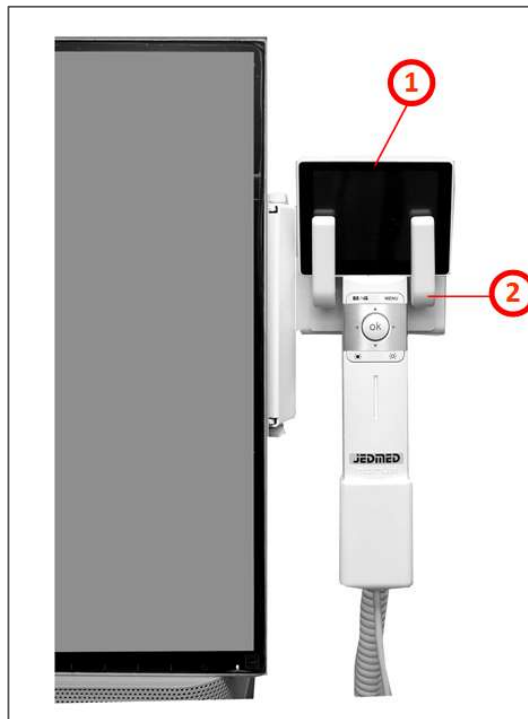

Figure 1. CLINiC with Horus Scope (1) and cradle assembly (2)

You can find additional CLINiC resources and information about support and other related telehealth services at www.ironbowhealthcare.com.

Installing the Horus Scope Cradle

The components of the Horus Scope cradle assembly are shown in the following figure.

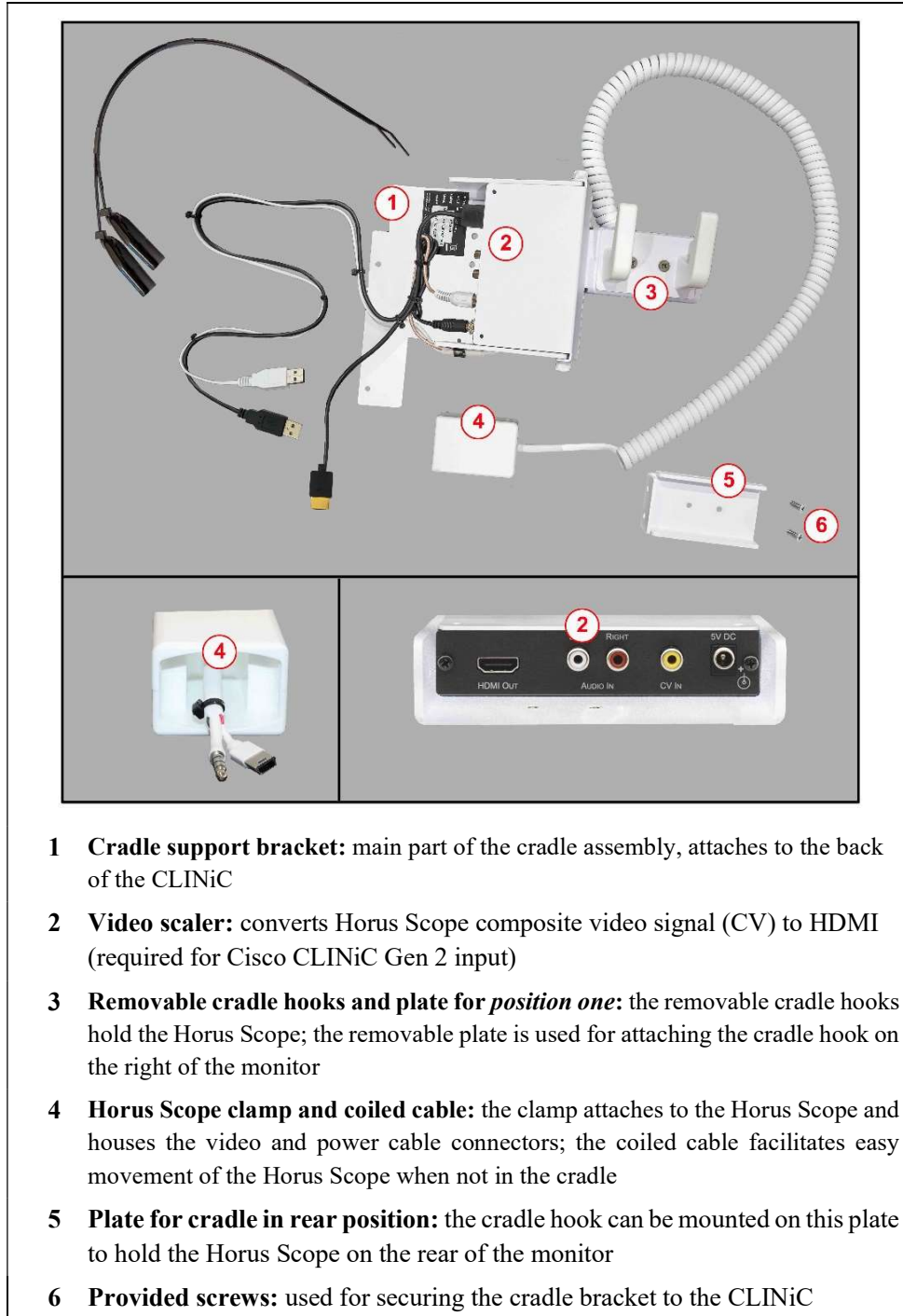

Figure 2. Horus Scope cradle attachment parts

The cables and cabling tool needed for connecting the Horus Scope to the CLINiC through the video scaler and cradle assembly are shown in figure 3 below.

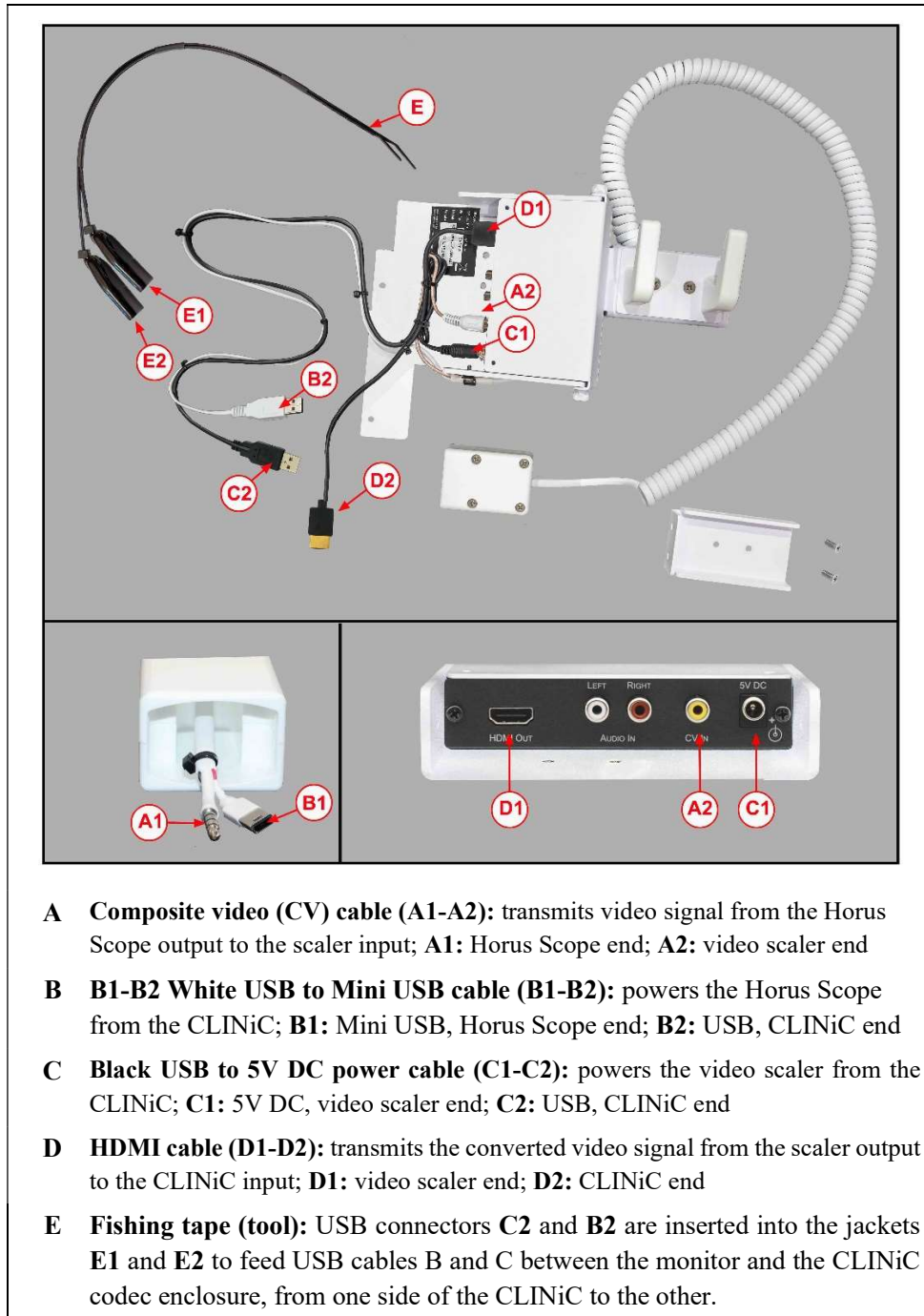

Figure 3. Horus Scope cables and cabling tools

The connection diagram between the Horus Scope and the CLINiC through the supplied video scaler, are shown in figure 4 below:

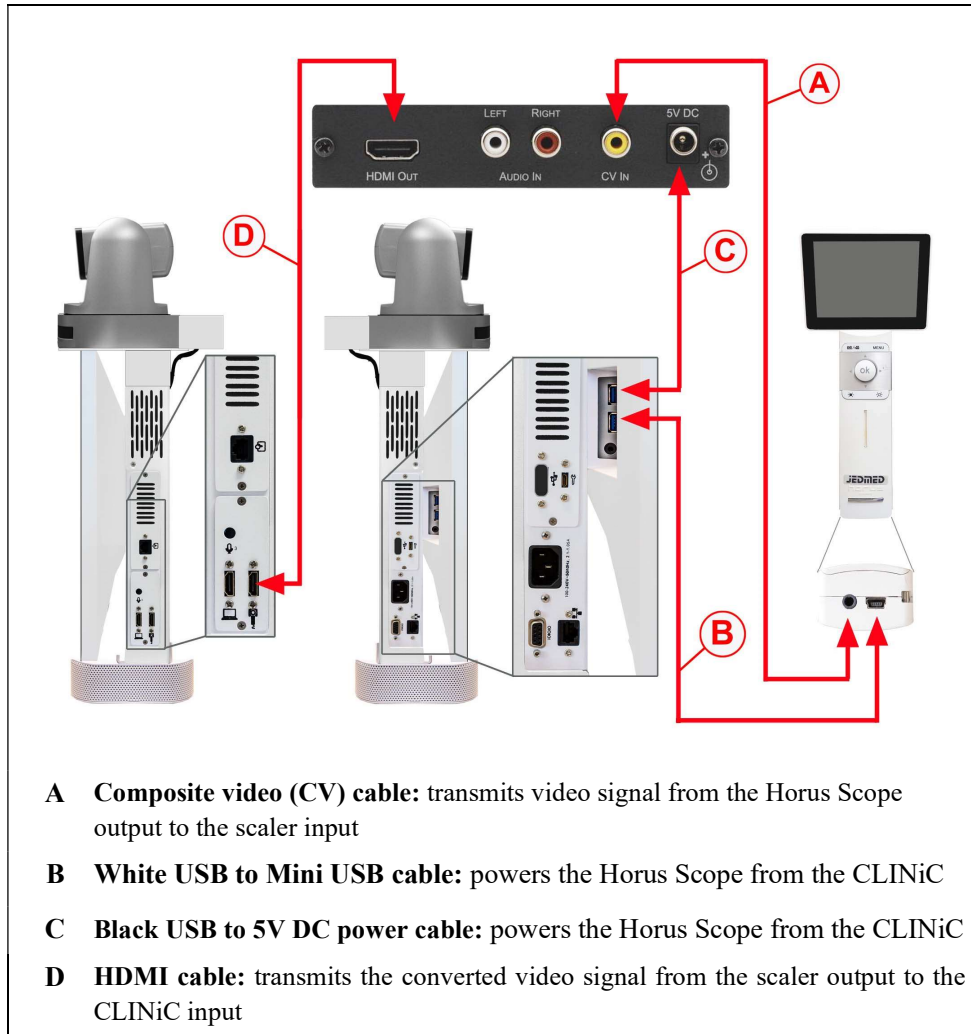

Figure 4. Horus Scope – CLINiC connectivity diagram

Preliminary Steps

Prior to installing the Horus Scope cradle onto the CLINiC, the CLINiC should be fully assembled, as shown below (the camera should be already mounted on the CLINiC).

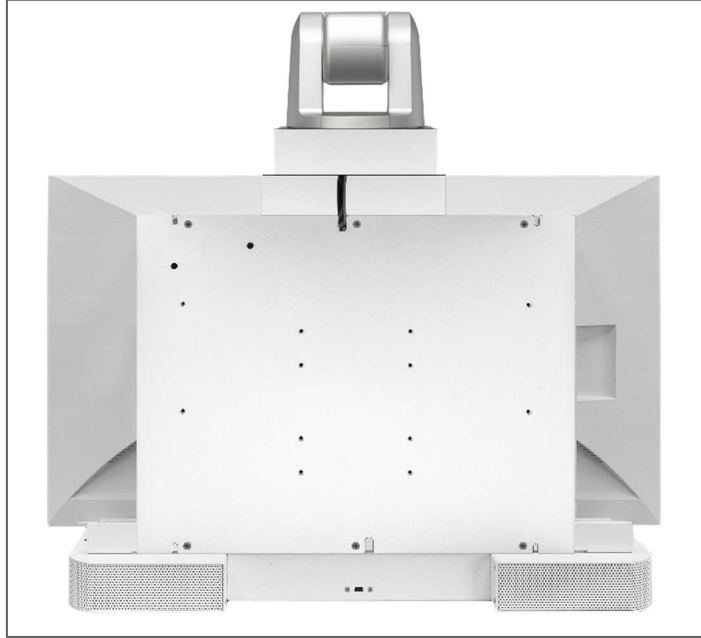

Figure 5. Fully assembled CLINiC 12x (rear view)

In addition, prior to attaching the clamp and coiled cable to the Horus Scope, make sure the Horus Scope has a working battery. To insert or replace a battery, see the instructions below.

Note: If the Horus Scope and the cradle were purchased together, the battery will be preinstalled in the Horus Scope. If that is the case, skip to the cradle assembly instructions.

To install the Horus Scope battery:

1. Open the battery cover by inserting your finger or a pointed tool in the gap at the bottom of the battery cover. Remove the battery cover by lifting it up.
2. Insert the battery with the positive end facing up.



Installing Cradle in Side-Mounted Position

The cradle can be mounted in two positions relative to the CLINiC. Side mounting provides easy access on the right hand side of the CLINiC, which may be ideal for frequent use. Rear mounting stores the Horus Scope on the back of the CLINiC, which reduces the overall width of the system, allowing greater mobility when mounted on a cart.

Note: A #2 Phillips head screwdriver will be required for the installation.

To install the cradle in Side Mounted position:

1. Vertically align the cradle mounting bracket with the holes on the back of the CLINiC, and attach using the provided screws.

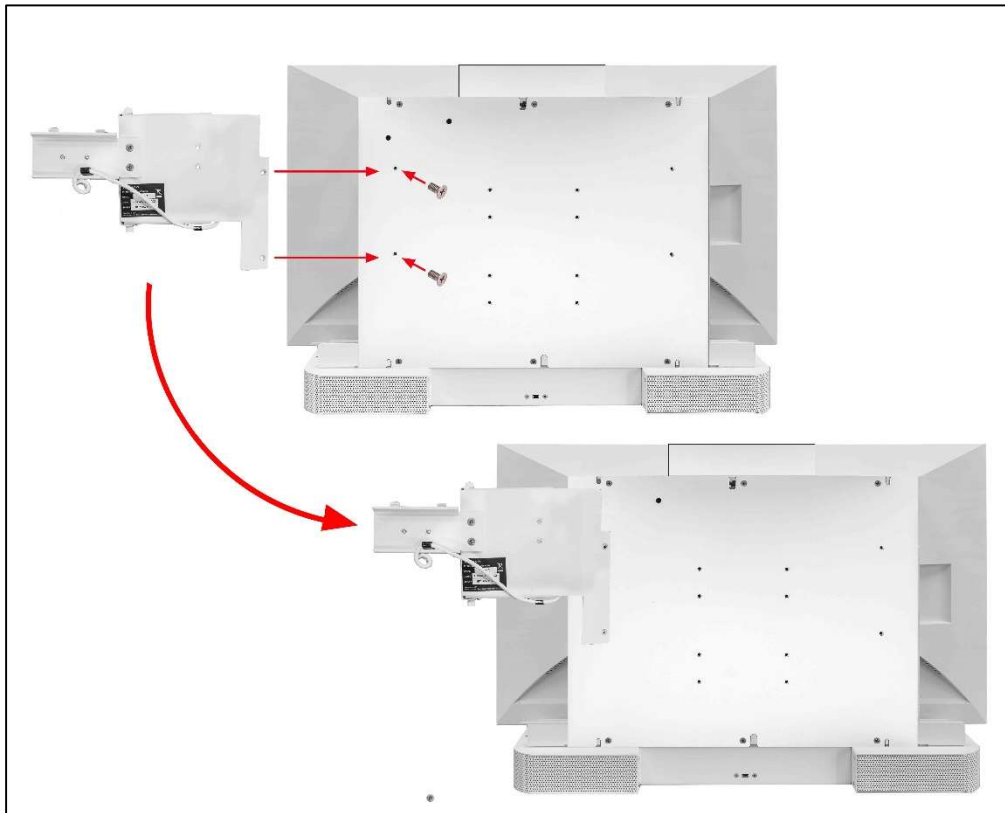

2. Insert the **B2** and **C2** USB connectors of the white and black USB cables into the **E1** and **E2** jackets of the fishing tape. The B2 and C2 USB connectors must be fed through to the CLINiC USB ports using the fishing tape (refer to Figure 4 connectivity diagram).

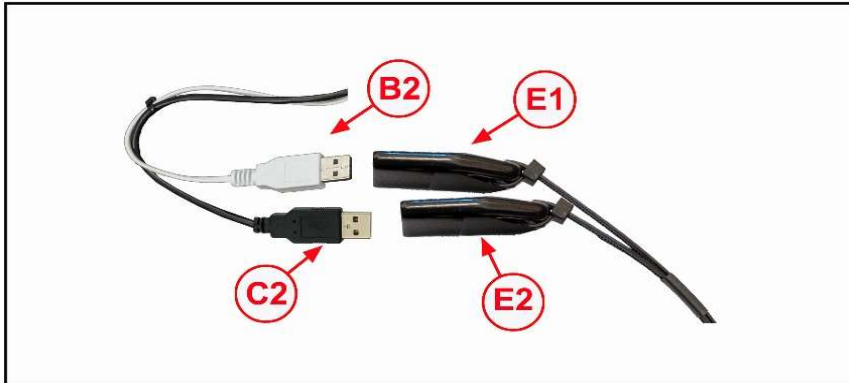

3. Feed the B2 and C2 ends of the white and black USB cables through the space between the monitor and the CLINiC codec enclosure, from the side of the CLINiC where the cradle assembly is mounted (1), all the way to the other side of the CLINiC where the USB ports are located (2).

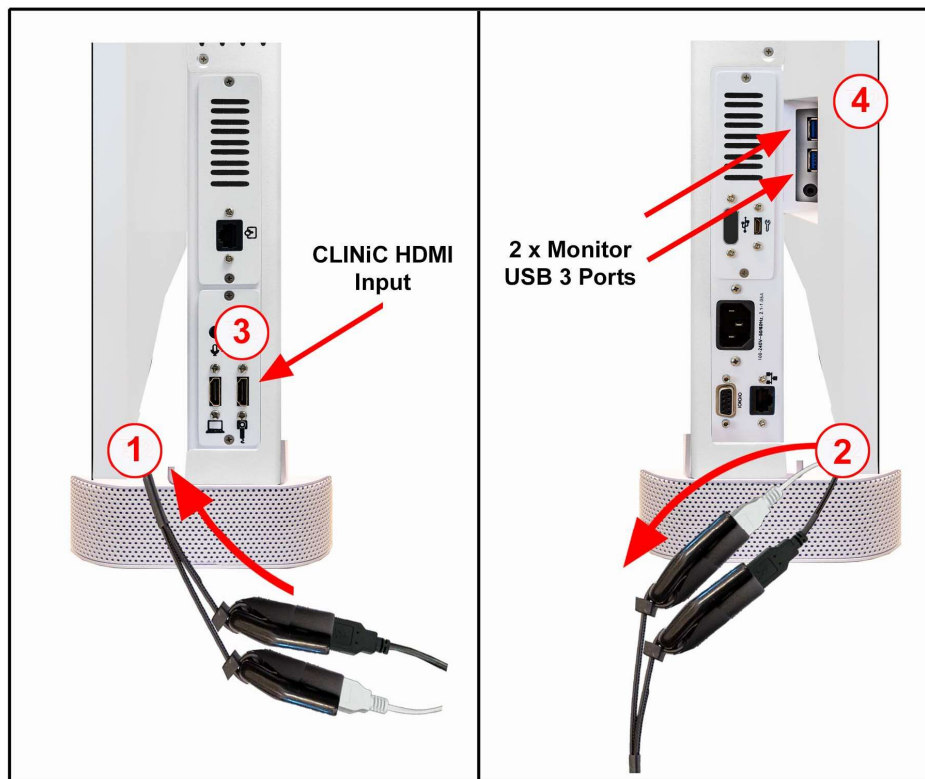

4. Once the B2 and C2 ends of the white and black USB cables have been pulled to the other side and can reach the CLINiC USB ports, remove the B2 and C2 connectors from the fishing tape and connect them to the CLINiC USB ports (4).
5. The HDMI Output cable already connected to the video scaler is now connected to the HDMI Input port on the side of the CLINiC (3)

Attaching Horus Scope Cable and Clamp

If the Horus Scope and the cradle assembly were purchased together, the Horus Scope will come pre-installed in the clamp. If purchased separately the cable assembly and clamp will need to be attached to the Horus Scope, as outlined below:

1. Remove the screws from the Horus Scope clamp (1) to expose the video and power cable connectors (2): composite video (A1) and Mini USB (B1)

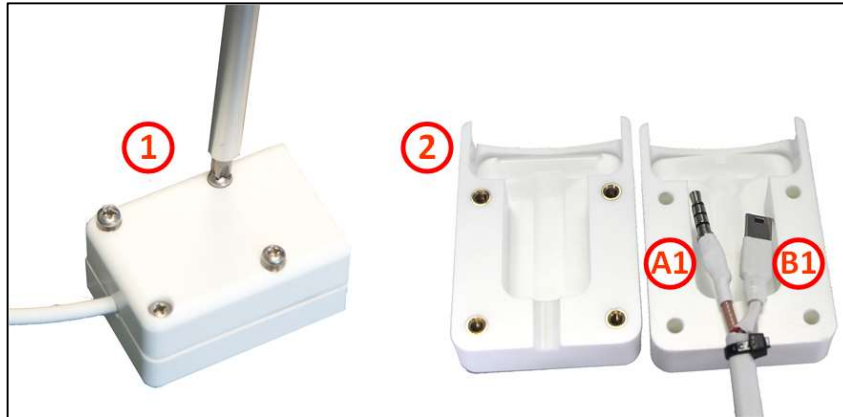

2. Place the Horus Scope in the bottom half of the clamp (the half that has metal screw holes), as shown. Insert the composite video and Mini USB connector into the corresponding ports at the bottom of the Horus Scope.



3. Put in place the top side of the clamp, as shown
4. Fasten the four screws.
5. Place the Horus Scope in the cradle.

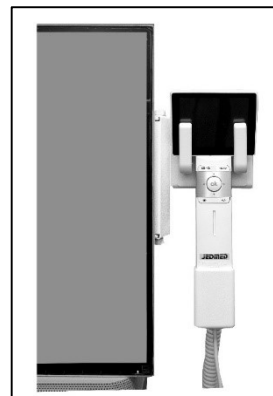

Moving Cradle from Side to Rear Mounting Position

The instructions below describe how to change the cradle from side mounting to rear mounting. To change from rear mounting to side mounting, reverse the instructions.

Note: A #2 Phillips head screwdriver will be required for the installation.

1. Remove the screws attaching the cradle hooks from the attached side mounting plate. Note: You will reuse the cradle hooks and screws later in this procedure when you will attach the hooks to the rear mounting plate.

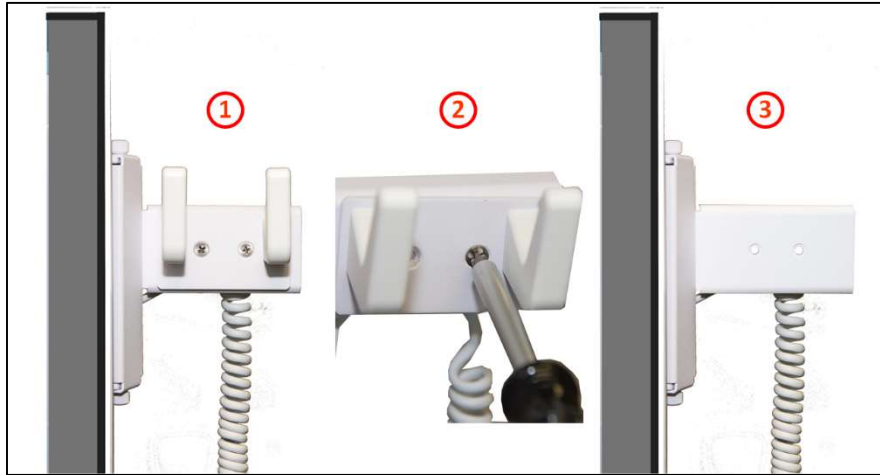

2. Remove the two screws attaching the side position plate to the cradle support bracket. The same screws are used to attach the rear mounting plate.



3. Remove the strain relief clamp holding the coiled cable to the side mounting plate.

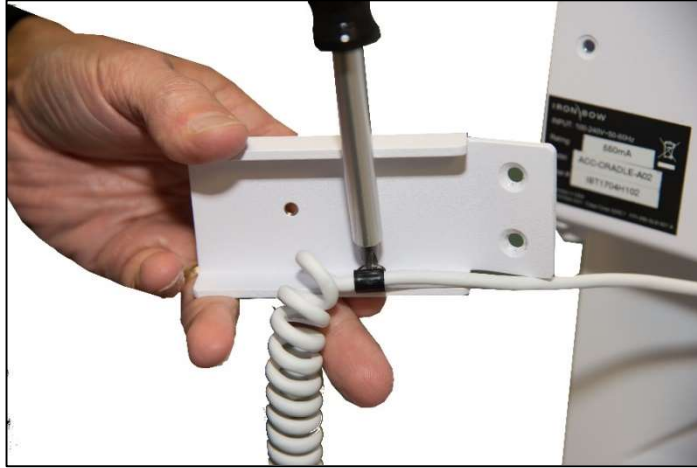

4. Fasten the strain relief clamp to hold the coiled cable to the rear mounting plate.
5. Place the rear mounting plate on the back of the cradle support bracket and secure with the same two screws that were used to side mounting plate.



6. Fasten the cradle hooks onto the rear mounting plate.

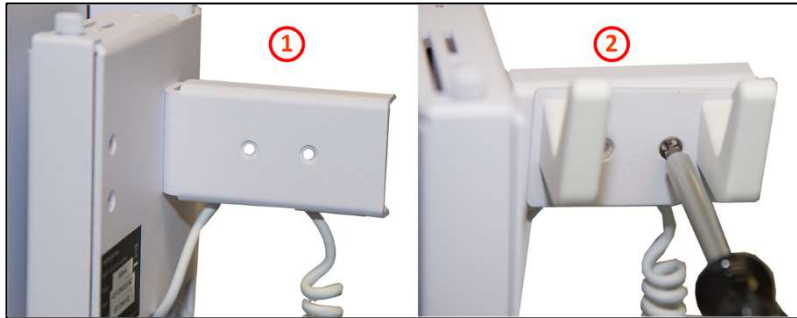

7. Place the Horus Scope into the cradle on the rear of the CLINiC.

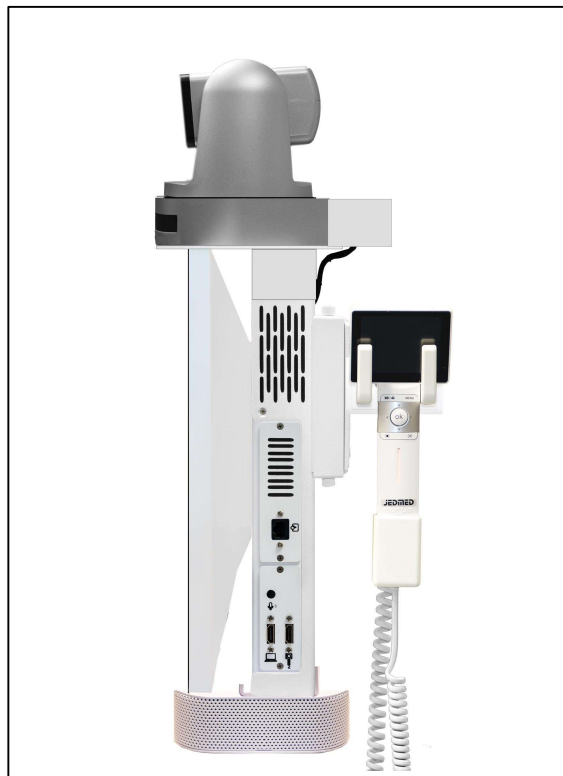

Operating the Horus Scope

The Horus Scope is used to capture and transmit images and video to a remote consulting clinician through the CLINiC. This section includes a summary of the Horus Scope functions and components, basic operation and troubleshooting tips.

Horus Scope Functions and Components

The Horus Scope functions and device components are listed below.

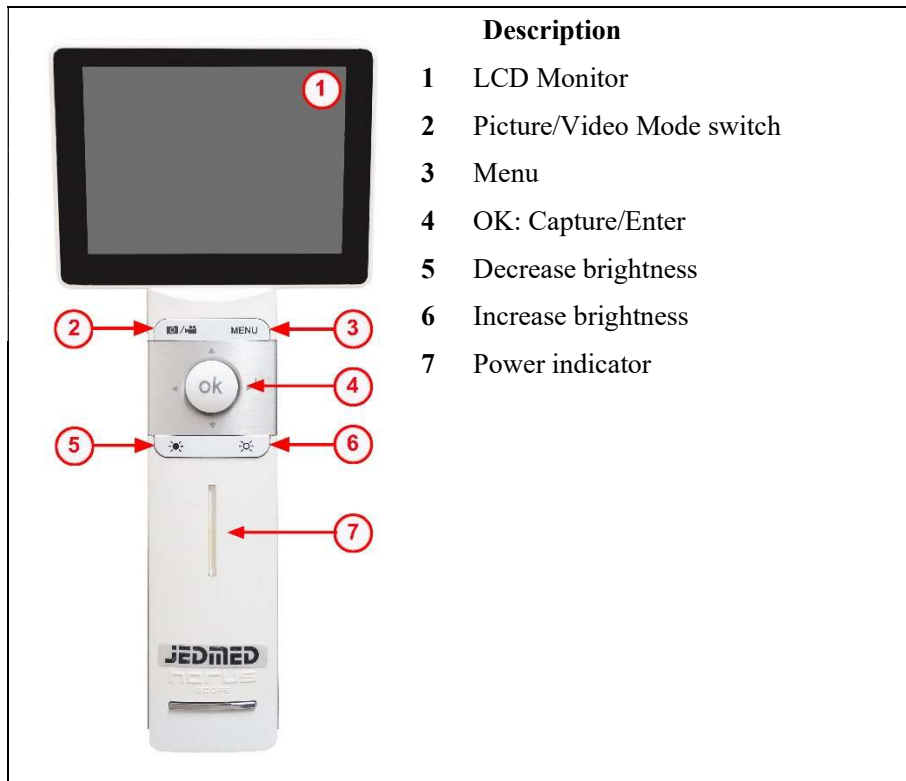

Figure 6. Horus Scope components (front view)

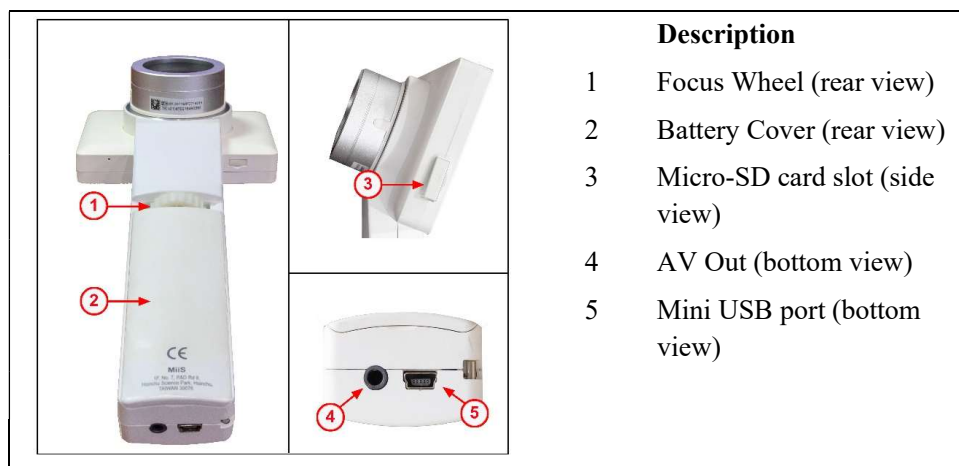

Figure 7. Horus scope components (rear, side and bottom views)

Basic Horus Scope Operations

To power on the Horus Scope:

- Press and hold the power button at the top of the unit for two seconds. The Horus Scope will start up. Start-up takes about 20 seconds.



Once the start-up procedure is complete the Horus Scope screen will display the live video feed captured by the lens currently attached to the unit.

To switch between live video and image capture:

1. Press the **OK** button on the unit to capture images.



2. Press the  button to return to live view.

Changing Horus Scope Lens Attachments

To remove optical lens attachment from the Horus Scope:

1. Hold the camera in one hand and rotate optical lens counter-clockwise with the other hand until the lens detaches.
2. Gently pull to detach lens.







To add optical lens attachment to the Horus Scope:

1. Hold the camera in one hand and the lens in the other hand
2. Align the ● marks on the optical lens and the camera body
3. Push the lens and the camera together
4. Rotate optical lens clockwise until secure

For more details regarding the Horus Scope features, menu options, operation and care instructions please consult the JEDMED Horus Scope User's Manual, which can be found at: <https://www.jedmed.com/pages/horus-scope-manuals>

For additional information regarding the Horus Scope operation with the CLINiC, please refer to the CLINiC User Guide.

Troubleshooting Tips

 <p>Connected Peripheral Device button on the CLINiC control panel</p>	<ul style="list-style-type: none">• Press  on the CLINiC control panel to display the Horus Scope video on the CLINiC. Note: The  button becomes active and can be used after the Horus Scope is powered-up and properly connected to the CLINiC.• If you see a blue screen instead of an image from the Horus scope, the video scaler is not receiving video from the Horus Scope. Ensure the Horus Scope is powered on, and that the video cable inside the clamp is properly seated in A/V output of the HORUS handle.• If you see a JEDMED logo instead of the expected image, ensure that the lens is properly attached to the Horus Scope handle. Consult the User Guide included with the Horus Scope for detailed installation and operation instructions of the Horus Scope device.• If after pressing  you do not see video images from the Horus Scope but after pressing  you do, the video source button assignment must be reversed. See Changing Video Source Button Assignment in the CLINiC user guide.
 <p>Connected PC button on the CLINiC control panel</p>	

Video Scaler Settings

The video scaler is configured to the optimized settings at the factory. The settings should not need to be changed. To confirm that the scaler is powered and still set optimally, remove the protective cover to reveal the front panel LEDs.

To remove the protective cover, remove the thumbscrews at the top and bottom of the video scaler cover.

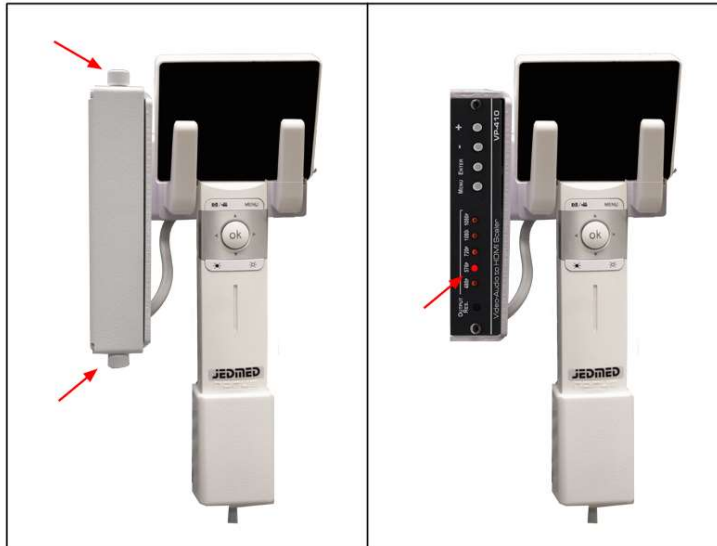

A properly configured video scaler will have the 576p LED lit and Aspect Ratio set to 4:3. The Aspect Ratio is configured via the on screen display using the Menu/Enter/- and + buttons.

If the video scaler is improperly set you can change the setting as follows.

To change output resolution settings:

- Press **Output Res.** to cycle through all available output resolutions options until **576p** is selected

Use a pointed object, such as a pen or paper clip, when pressing the **Input Select** and **Output Res.** buttons.

To change Aspect Ratio settings:

- Press the MENU button to enter or exit the menu
- Press the ENTER button to enter or exit a parameter to change its value
- The + and – buttons have two functions:
 - Press the buttons to move up or down through the parameters
 - Press the buttons to increase or decrease, or cycle through the parameter values

If there are no lit LED on the front of the video scaler, this indicates the video scaler is not receiving power. If that is the case, perform the following checks:

- Ensure that the CLINiC is powered on by looking at the system display.
If the CLINiC is powered on, ensure that the black USB cable is properly seated in the CLINiC USB port.



2303 Dulles Station Boulevard, Suite 400
Herndon, VA 20171

Toll: 800.338.8866
Tel: 703.279.3000

www.ironbowhealthcare.com